

SEC 2000 Gas Detector

SUPREME AIR SYSTEMS LTD.

6660-D Ordan Drive
Mississauga, Ontario, L5T 1J7
Tel: (905) 565-8666 Fax: (905) 565-8633
Toll Free: 1 (866) 277-5977
www.supremespray.com

Features

- Designed for hazardous environments
- Low-cost installation
- Over 20 different gases detected
- CSA/NRTL approved
- Combustible detector UL approved
- Industry standard 4-20 mA output
- RS-485 digital output
- User friendly, one person calibration
- Provides continuous self-diagnostics
- Combustible, toxic and oxygen deficiency detectors
- Retains operating parameters and calibration settings when powered down
- Operates with SEC Supervision Plus Hazard Event Monitoring Software
- Inexpensive non-display units available
- Relays can be set to turn on alarms, shut doors, turn on fans

Applications

- Petrochemical Refineries
- Compost Facilities
- Semi-Conductor Industry
- Mining
- Pulp and Paper Mills
- Oil Rig Platforms
- Buildings
- Automotive Industry
- Engine Test Rooms
- LNG & LPG Facilities
- Sewage Industry
- Water Treatment Plants
- Parking Garages
- Chemical Industry
- Nuclear Industry
- Fertilizer Industry
- Tunnels
- Medical Facilities

Operation

The SEC 2000 is a digital gas detector, that is designed to detect one of a number of gases, display the concentration of that particular gas, and provide an alarm when gas concentrations reach preset levels. The SEC 2000 will operate as a stand-alone gas detector with its own relay outputs and LED display. An industry standard 4-20 mA output enables the SEC 2000 to be connected to analog systems, such as PLC, DCS, and TMR systems.

The SEC 2000 operating parameters (relay action, alarm set values, sensor configuration, etc.) can be viewed or changed using the SEC 2500 Hand Held Programmer or SEC Supervision Plus software. The 2500 can communicate anywhere on the network with any SEC 2000 using either an infrared link, an RS-485 data highway, or by plugging directly into any SEC 2000.

An RS-485 digital output enables the SEC 2000 to communi-

cate to a PC running Supervision Plus software or SEC 4100 System Monitor. The SEC 2000 network is formed by connecting a single twisted shielded pair of cable wires, reducing cabling and installation costs.

A push-button magnetic switch is used to perform a non-intrusive calibration. The calibration sequence is user-friendly and requires only one person.

The SEC 2000 retains operating parameters and calibration settings when powered down. An on-board microprocessor provides continuous self-diagnostics and identifies problems using fault codes. Four (4) 8 amp SPDT relays respond to Low, Mid and High gas alarms as well as any fault conditions. Calibration gas values can be changed without opening the SEC 2000 housing, using the magnetic push-button switch for calibration.

SEC 2000

Gas Detector

Specifications

Detection Method

Combustible Gas - Infrared & Catalytic -LEL
Toxic Gases - Electrochemical
Oxygen - Galvanic

Sampling Method

Diffusion, optional sample-draw

Alarms

Visual indication and relay contacts for low, mid, high and fault

Output (digital)

RS-485 LAN

Output (analog)

4-20 mA (source type), max. 1000 ohm load at 24 VDC supply voltage

Relay Operation

Selectable latching or non-latching
Selectable normally energized or normally de-energized (except fault)
Selectable alarm relay off delays
Manual relay control

Housing Construction

Electronics - epoxy coated explosion-proof aluminum housing
Sensor - anodized explosion-proof aluminum housing, optional stainless steel

Available Standard Gases*

Combustible	(LEL)	Carbon Monoxide	(CO)
Oxygen	(O ₂)	Germane	(GeH ₄)
Hydrogen	(H ₂)	Silane	(SiH ₄)
Ammonia	(NH ₃)	Phosphene	(PH ₃)
Nitric Oxide	(NO)	Sulfur Dioxide	(SO ₂)
Bromine	(Br ₂)	Nitrogen Dioxide	(NO ₂)
Fluorine	(F ₂)	Chlorine Dioxide	(ClO ₂)
Arsine	(AsH ₃)	Hydrogen Sulfide	(H ₂ S)
Ozone	(O ₃)	Hydrogen Fluoride	(HF)
Chlorine	(Cl ₂)	Hydrogen Chloride	(HCl)
Phosgene	(COCl ₂)	Hydrogen Cyanide	(HCN)
Diborane	(B ₂ H ₆)	Hydrogen Selenide	(H ₂ Se)
Formaldehyde	(HCHO)	Hydrogen Peroxide	(H ₂ O ₂)
Ethylene Oxide	(ETO)		

*For sensitivity range and additional gases please contact Sensor Electronics.

Operating Voltage

24 VDC, Operating 18 to 32 VDC (measured at detector head)

Power Consumption

Combustible - 2.5 Watts nominal
3.6 Watts maximum
Toxic gases and oxygen - 2.5 Watts nominal
3.6 Watts maximum

Temperature Rating

-40° to +70°C (300 F)

Toxic gas sensors temperature range may vary please consult with Sensor Electronics.

Relay, Type and Rating

SPDT: 8 Amps @ 250 VAC
8 Amps @ 30 VDC

CSA/NRTL Certification

Combustible, Toxic and Oxygen
Class I, Division 1, Groups B, C and D
CSA file # LR 95495

UL Certification

Combustible — Catalytic
Class I, Zone 0, 1 and 2 Hazardous Locations
UL file # E127700

RFI

Tested to military standard 462C

Housing Dimensions

6.5 (W) x 7 (L) x 6.5 (H) inches
(165 (W) x 178 (L) x 165 (H) mm)

Weight

Approximately 7 lbs (3.2 Kg)

Other Products Available:

Infrared Hydrocarbon Gas Detectors
Non-Explosion Proof Gas Detectors
Data Logging/Graphics Software Packages
Optical UV/IR Flame Detectors
Fire Suppression Aerosol Generators
Portable Automatic Fire Fighting Systems
Halotron Systems
Twin Agent Units
Dry Chemical Mobile and Stationary Units

SUPREME AIR SYSTEMS LTD.

6660-D Ordan Drive

Mississauga, Ontario, L5T 1J7

Tel: (905) 565-8668 Fax: (905) 565-8633

Toll Free: 1 (866) 277-3977

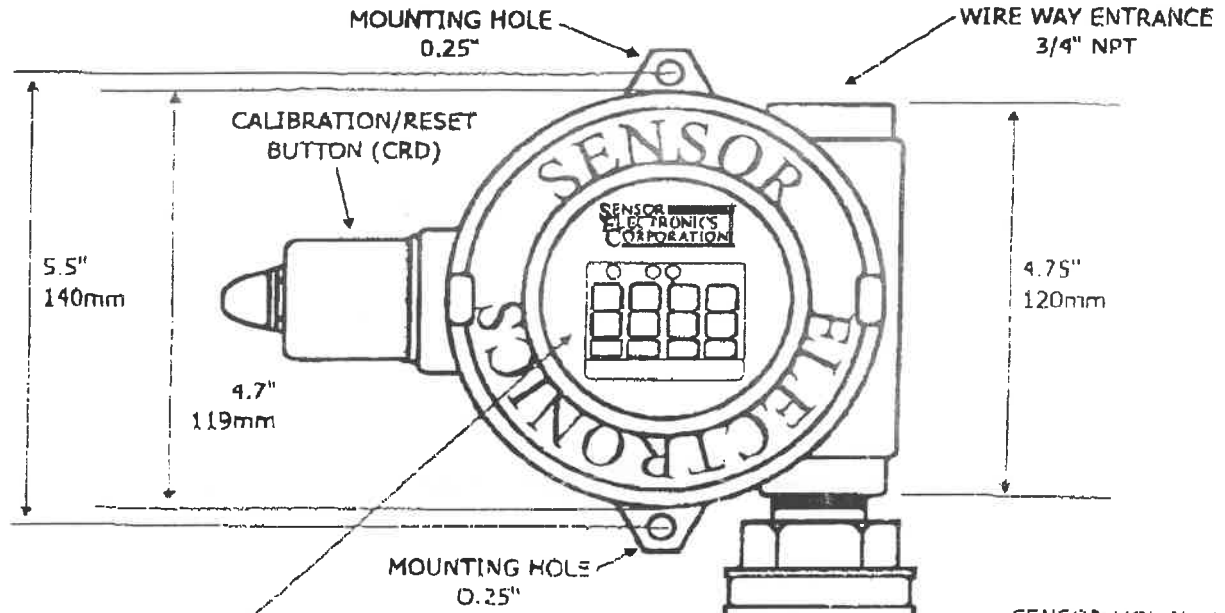

DIGITAL DISPLAY
 TRI-COLOR LED INDICATORS
 For POWER
GREEN STEADY = Power On, Normal
RED = Fault
 For Alarms LOW, MID and HIGH
GREEN = Normal
RED = Alarm
AMBER = When concentration has returned to below alarm setpoint and relays are latched.

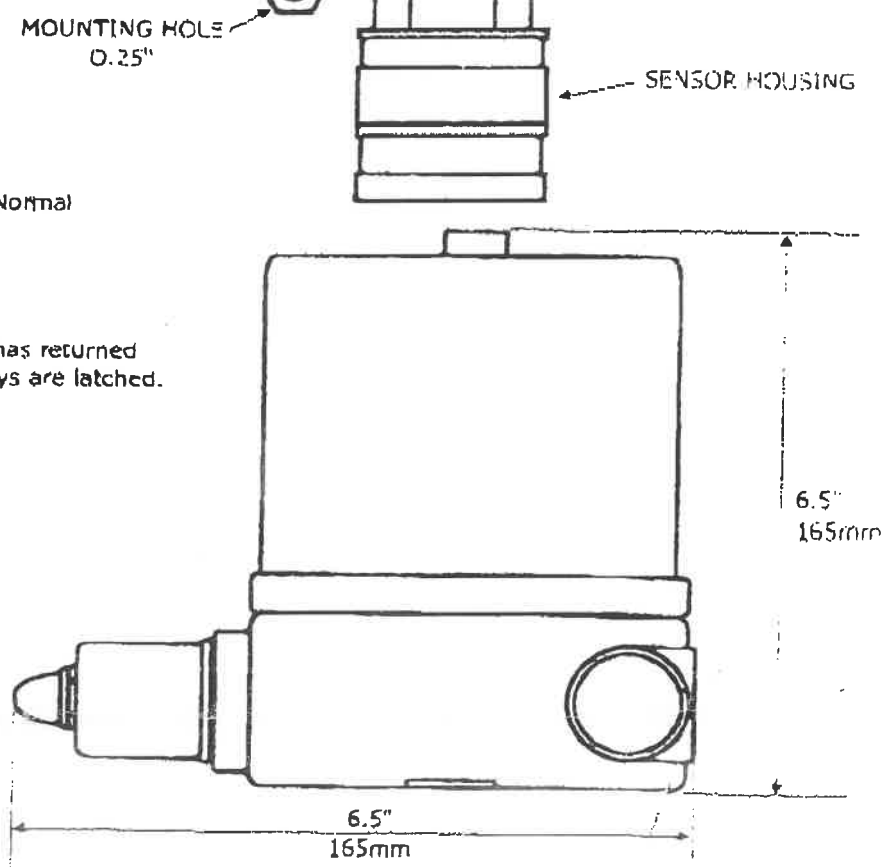

SUPREME AIR SYSTEMS LTD.
 6000 Steeles Ave. E.
 Mississauga, Ontario L4T 1J7
 Tel: (905) 565-8666 Fax: (905) 565-8633
 Toll Free: 1 (866) 277-3077
 www.supremesystems.com

SEC 2000 OVERALL LAYOUT

FIGURE 1

POWER SUPPLY BOARD FOR COMBUSTIBLE SENSORS

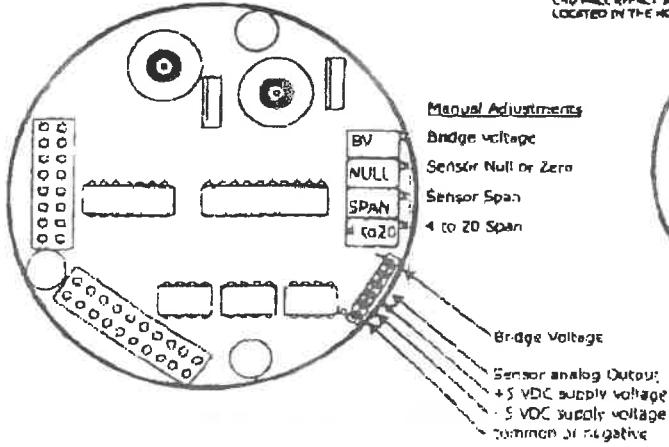

CONNECTIONS FOR THE CRD HALL EFFECT SWITCH LOCATED IN THE HOUSING

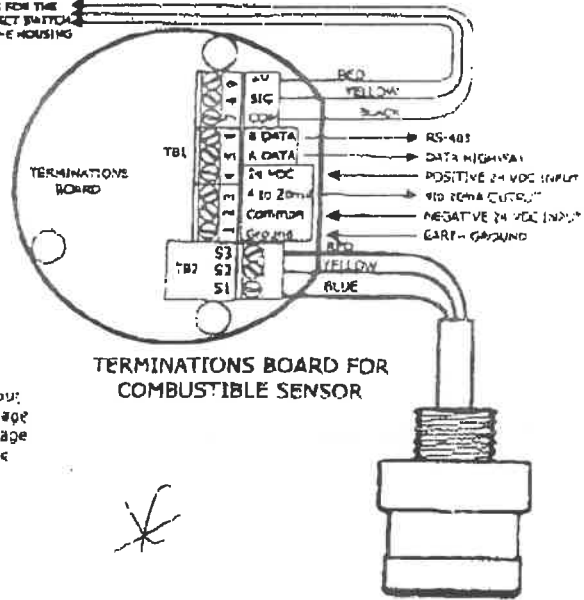

RELAY BOARD

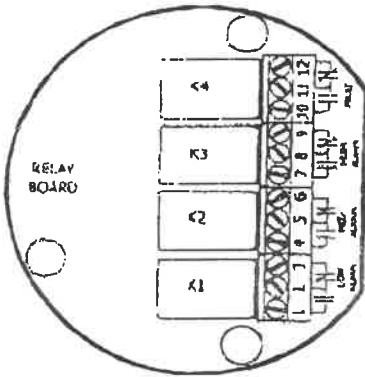

POWER SUPPLY BOARD FOR TOXIC AND OXYGEN SENSORS

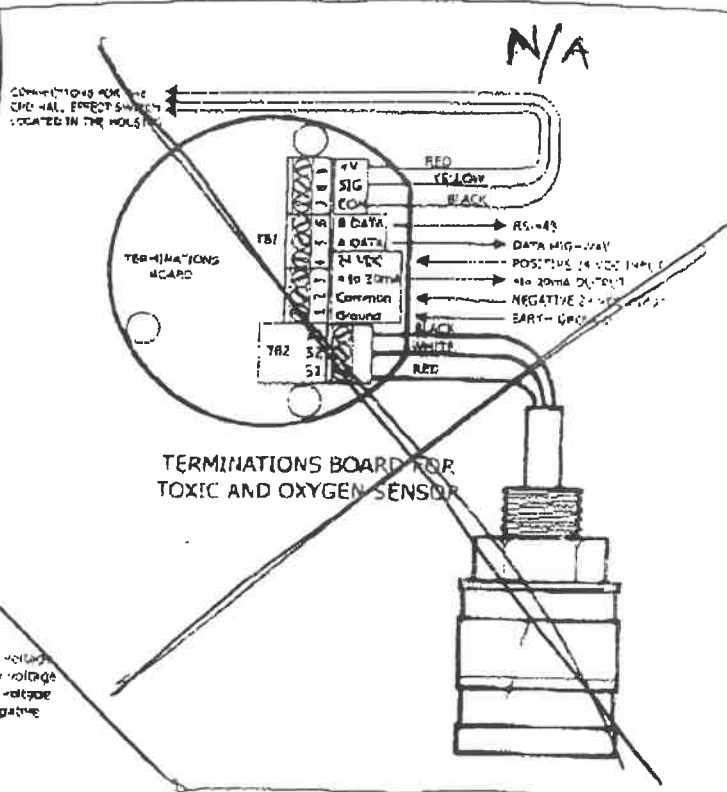
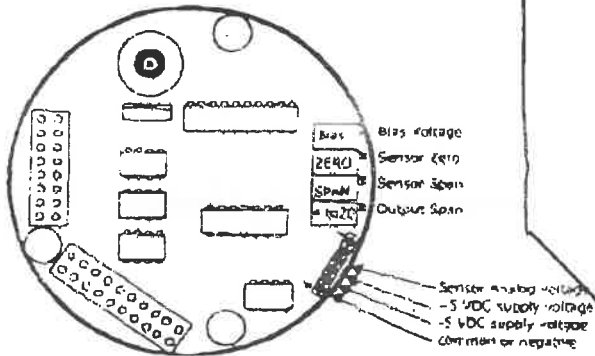

SUPREME AIR SYSTEMS LTD.

6660-D Ordan Drive

Mississauga, Ontario, L5T 1J7

Tel: (905) 565-8666 Fax: (905) 565-8633

Toll Free: 1 (866) 277-3977

www.supremespray.com

SEC 2000 WIRING
DETAIL

FIGURE 2